



(980) 689-4389

18805 W Catawba Ave - Cornelius, NC

# TRENCH SHIELD TABULATED DATA



<b>Model Number</b>	TSB6-820	<b>Spreader Size</b>	8" Sch. 80	<b>Pressure Rating</b>	1,573 psf
<b>Serial Number</b>	TSB6820-218A/B	<b>Spreader Yield Strength</b>	35 ksi	<b>Weight</b>	10,900 lb.
<b>Height</b>	8'	<b>Max Spreader Length</b>	20'	<b>Vert. Pipe Clear</b>	64"
<b>Length</b>	20'	<b>Spreader Pin Diameter</b>	2"	<b>Horiz. Pipe Clear</b>	17'-11"
<b>Wall Thickness</b>	6"	<b>Pin Yield Strength</b>	100 ksi		

SOIL TYPE	Max Depth	Hs	Max Slope	Sloping & Shoring	
A-25	40'	10.5'	3/4(Horiz.) : 1(Vert.)	<b>1)</b> "Max Depth" shall not exceed limits outlined in table for corresponding soil types. <b>2)</b> If "Max Depth" is 20' or less, slope and shore per OSHA guidelines. <b>3)</b> If "Max Depth" exceeds 20', slope angle shall not exceed "Max Slope", and distance from top of shield to top of slope shall not exceed "Hs", as outlined in table for corresponding soil types.	
B-45	37'	8.5'	1(Horiz.) : 1(Vert.)		
C-60	29'	6.5'	1.5(Horiz.) : 1(Vert.)		
C-80	23'	0'	Flat		

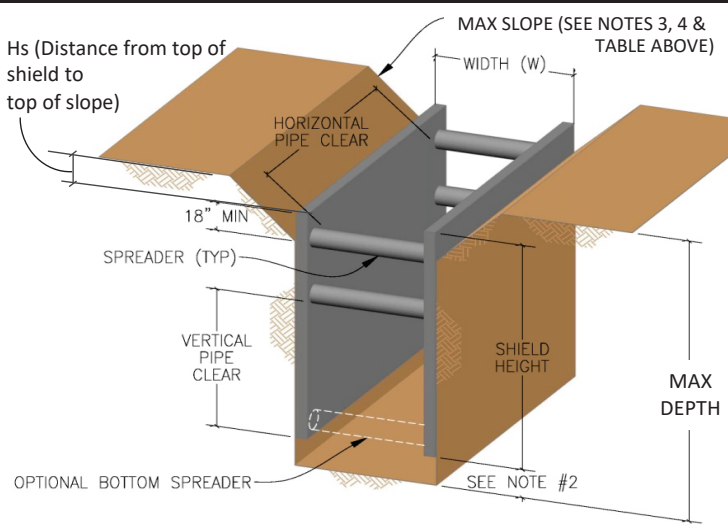

<b>33% Shoring Use Factor Included in Max Depth Ratings</b>	Yes
<b>Surcharge Pressure Included in Max Depth Ratings*</b>	72 psf

**\*All equipment and materials shall be kept a sufficient distance clear of the shoring, as directed by a licensed Professional Engineer, to ensure this surcharge limit is not exceeded.**

**Soil shall be classified by a Competent Person as type A, B or C, as defined by OSHA regulations, except as noted below:**

- 1)** A type C-60 soil is defined as a clay or moist granular soil that is not flowing or submerged. This soil can be cut vertically and will stand long enough to safely install protective system.
- 2)** If the soil is submerged or has freely seeping water, it shall be classified as a C-80 soil.
- 3)** Shielding shall never be used in soft clays, organic peat or other flowing materials.

### NOTES & LIMITATIONS:

- Refer to page 2 for manufacturer's assembly instructions.
- Excavation 2' below bottom of shield is only permitted when there is no indication of possible loss of soil from behind or below the bottom of the shield.
- Sloped soils must extend to no less than 18" below the top of the shield, as shown in diagram above. Shield need not extend above soil when soils are flat and level with top of shield.
- Except as approved in table above (Hs), any excavations over 20'-deep with sloping require site specific approval by a Licensed Professional Engineer (P.E.).
- User is responsible for safe support of shield to ensure it cannot shift vertically or horizontally at any time
- Shield may be stacked, provided that appropriate connections are made between the stacked shields to prevent lateral movement.
- Shield must be used in strict compliance with all applicable OSHA guidelines and limitations outlined in this document
- This document has been prepared by a P.E., as required by OSHA 29 CFR, Part 1926, Subpart P.
- Shield shall be used under the supervision and direction of a Competent Person as defined by CRF, Part 1926, Subpart P. Among other qualifications, the Competent Person shall be trained in the use of trench shields and have practical field experience with the use of shields, soil classification, and recognizing hazardous conditions.
- All spreaders shall be secured to sockets with pins or other mechanical connections approved by the manufacturer, prior to shield use. Do not apply side load or vertical load to the spreaders at any time (such as leaning plates/sheeting for soil support), unless approved in writing by a P.E. or the Manufacturer.
- Shield shall be installed in a manner to restrict lateral or other hazardous movement of the shield in the event of the application of sudden lateral loads.
- Shield shall be inspected prior to each use, to ensure they are in good condition and free of any damage or visual defects.
- Any repairs or modifications to the shield, such as extending height or length with plates, are strictly prohibited, unless approved in writing by a P.E.
- Pressure rating of shield is a uniform rectangular pressure over full height of shield.



The information contained herein has been compiled and authored exclusively by the manufacturer named herein. NAXSA disclaims all liability of any kind and nature for the accuracy and completeness of this information, or any use or reliance thereon, and disclaims all warranties, express or implied.